

x 2

L = 210

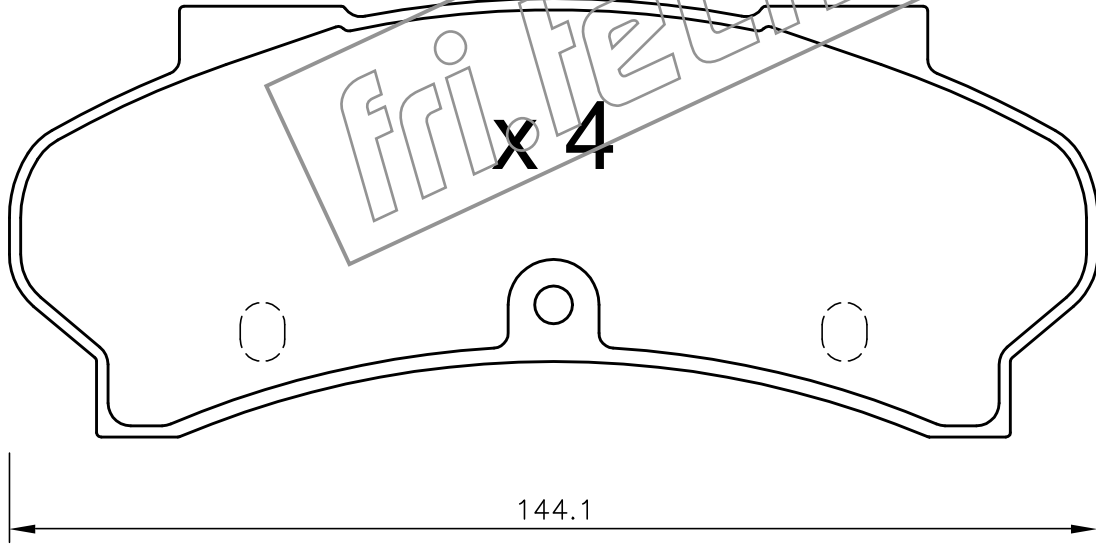
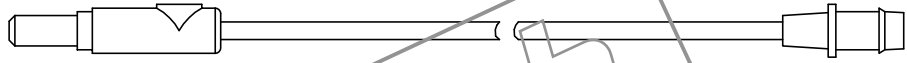

fri.tech.