

x 2

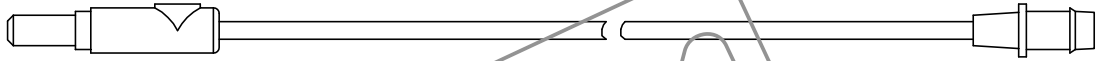

L = 380

x 4

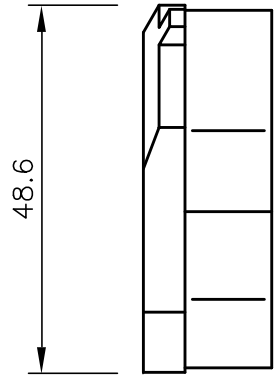
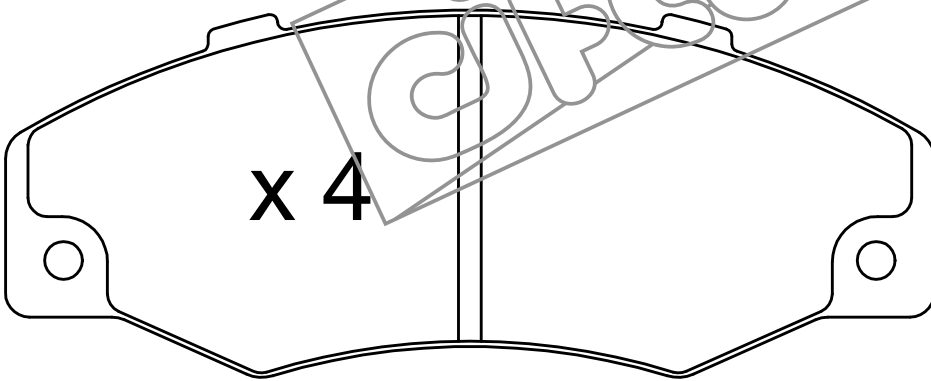

48.6

123

17

