

x 1

L = 220

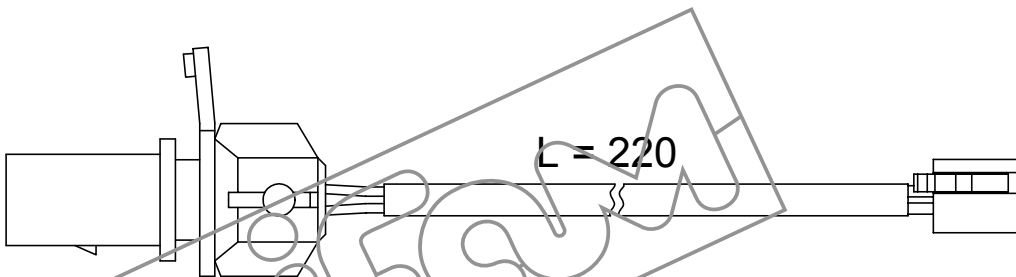

x 4

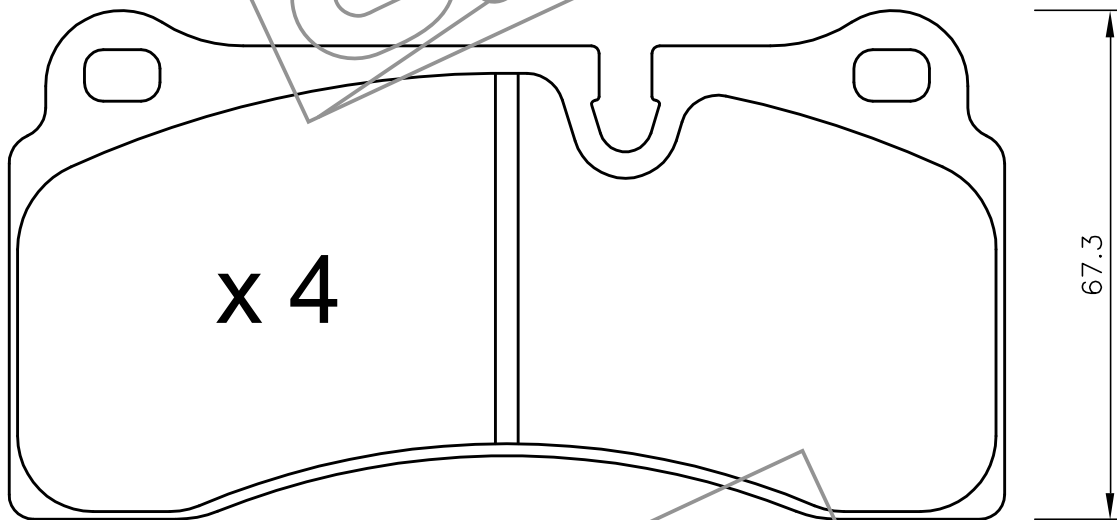

67.3

131.7

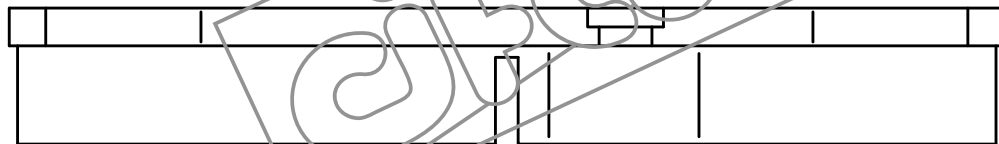
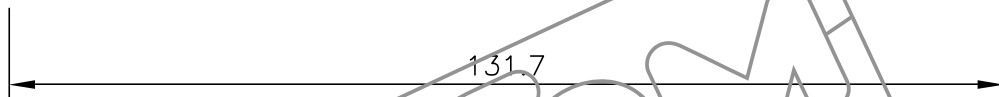

18

